

Part No.: S12GY9C



Features:

- Highest Flux Yellow (Amber)
- High reliability and Very long operating life (up to 100K hours)
- Low voltage DC operated
- More Energy Efficient than Incandescent and most Halogen lamps
- NO UV
- Superior ESD protection

Typical Applications:

- Reading lights(car,bus,aircraft)
- Portable(flashlight,bicycle)
- Automotive Exterior(Stop-Tail-Turn, CHMSL,Mirror Side Repeat)
- Decorative

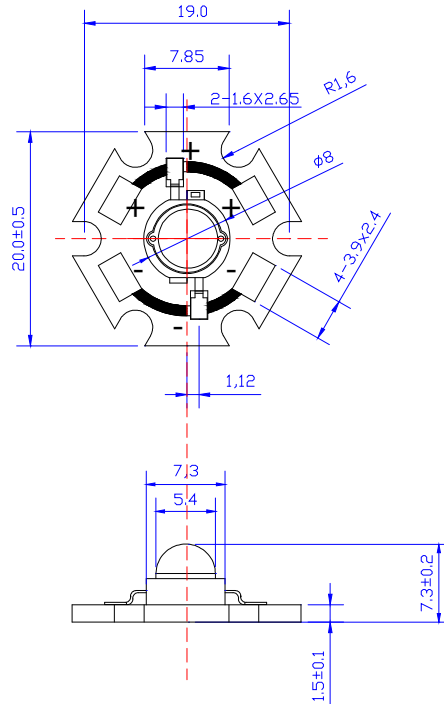

NOTE:

- All dimensions are millimetres.
- Tolerance is ± 0.1 mm unless otherwise noted

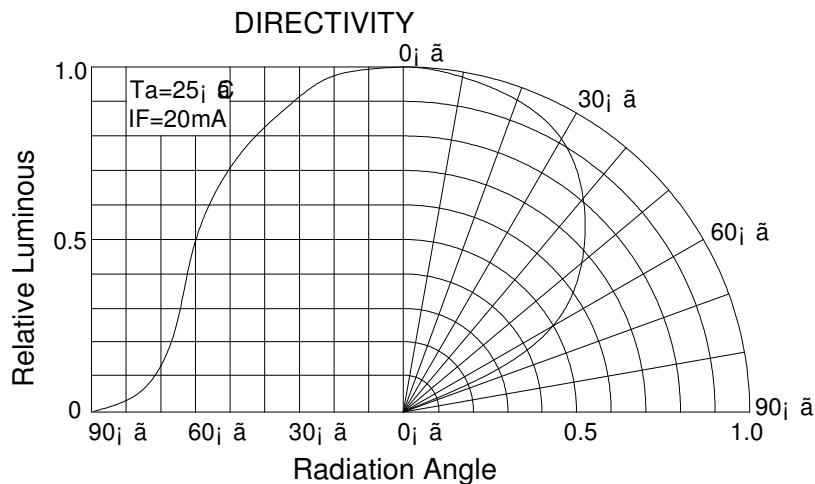

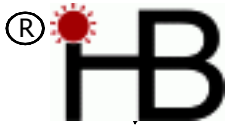

Part No.: S12GY9C

Absolute maximum ratings (Ta = 25°C)

Parameter	Symbol	Test Condition	Value		Unit
			Min.	Max.	
DC Forward Current	IF	----	----	350	mA
Peak Pulse Current	Ipeak	Duty=0.1mS, 1kHz	----	500	mA
Power Dissipation	Pd	----	----	0.98	W
LED Junction Temperature	Tj	----		120	°C
Operating Temperature	Topr	----	-25	+100	°C
Storage Temperature	Tstr	----	-40	+120	°C
ESD Sensitivity	---	HBM	8000	---	V
Soldering Temperature	---	-----	260°C for 5 Seconds max		

Electrical and optical characteristics (Ta = 25°C)

Parameter	Symbol	Test Condition	Value			Unit
			Min.	Typ.	Max.	
Forward Voltage	VF	IF = 350mA	----	2.5	2.8	V
Luminous Flux	Φv	IF = 350mA	5	10	15	lm
Viewing Angle	2 θ 1/2	IF = 350mA	----	120	----	Deg.
Dominant Wavelength	λd	IF = 350mA	590	----	595	nm

Luminous Flux Bins (Ta = 25°C)

Unit:lm

Bin	B	C	D	E	F	G
Min	5	10	15	20	25	30
Max	10	15	20	25	30	40

Dominant Wavelength- λd (Ta = 25°C)

Unit: nm

Bin	Q	R	S	T		
Min	580	585	590	595		
Max	585	590	595	600		



Part No.: S12GY9C

Typical electrical/optical characteristic curves:

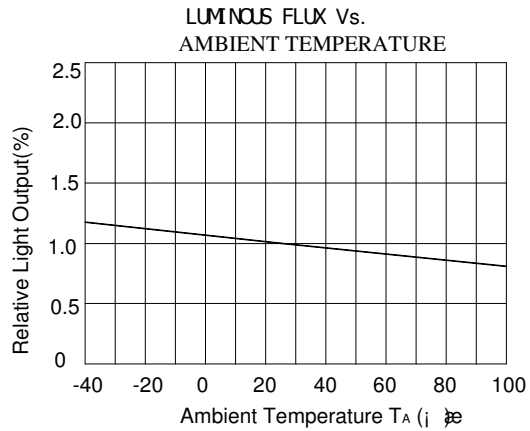
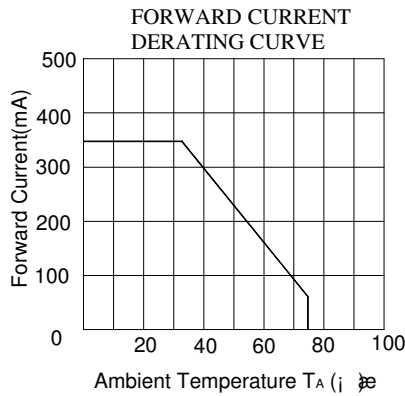
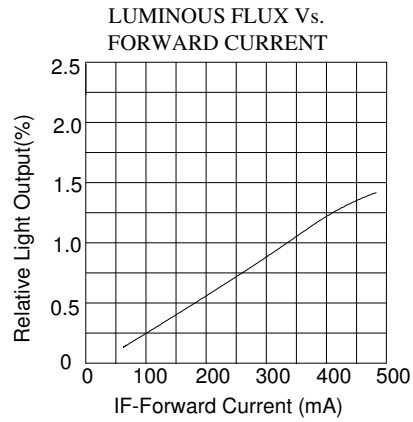
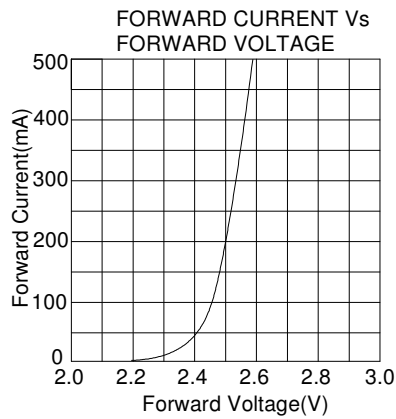

592/35

